

Varenummer: 25220465002

Beskrivelse: ICME Asynkronmotor MD100 B4 2,2KW
1400 o/m 1x230 V B14 med start- & driftskondensator

Mål

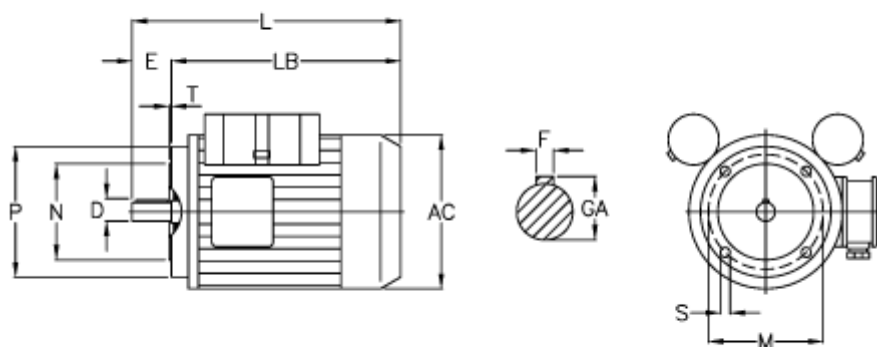

AC = 195	M = 130
D = 28	N = 110
E = 60	P = 160
F = 8	S = M8
GA = 31	T = 3.5
HB = 140	Z = 260
L = 403	
LB = 343	